

INSTALLATION GUIDE

F102

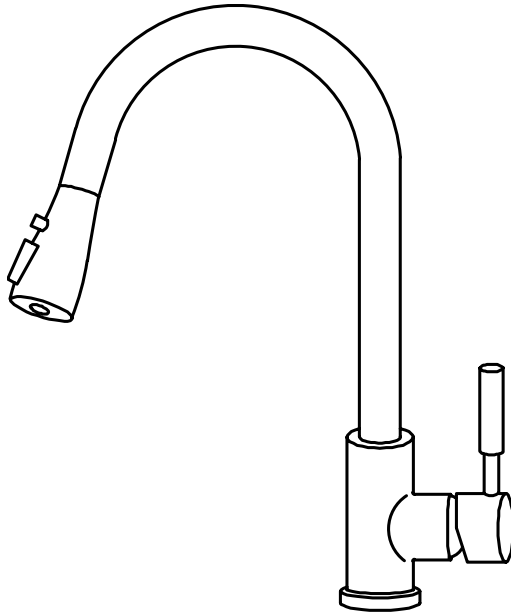

INSTALLATION

1

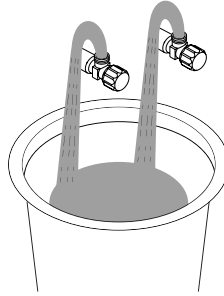

Shut off water suppliers. Remove the old faucet, clean the mounting surface.

Note: For first time install, flush the pipes first by open the angel valve to run 60s.

2 For Single-Hole Sinks:

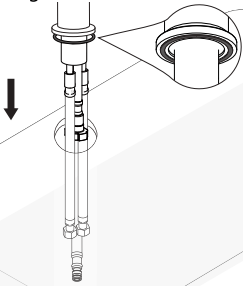

Put the rubber O-ring into the bottom gap of faucets then Insert faucet into faucet hole.

3 For Three-Hole Sinks:

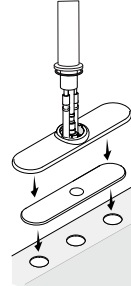

Put the rubber O-ring into the bottom gap of faucets then Insert faucet into faucet hole.

4

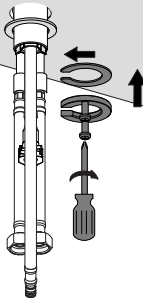

From underneath the countertop, Slide rubber washer, metal washer and mounting bracket onto the thread shank.

5

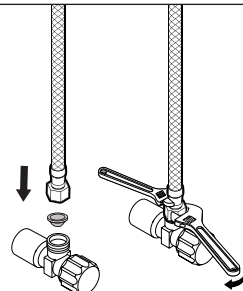

Connect and tighten the supply hoses by using two adjustable wrenches (avoid twisting or kinking).

Note: Do not remove the net filter that attached into the connecting end!

6

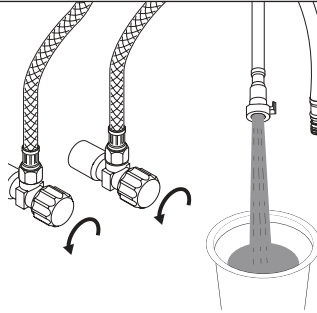

Turn on water suppliers. Place a bucket below outlet tube, slowly open and close the supply angle valves, **This will prevent debris from being lodged in the hose and sprayer.**

7

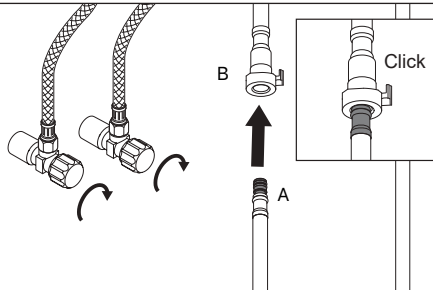

Shut off water suppliers. Push the handspray hose(A) into the quick connector(B) until you hear a click sound. Make sure it's secured.

8

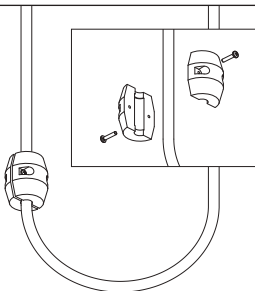

Install the hose weight on the outlet side of the hose, suggested installation position is marked on the hose.

Test the handspray hose. If it does not retract smoothly, reposition the weight.

9

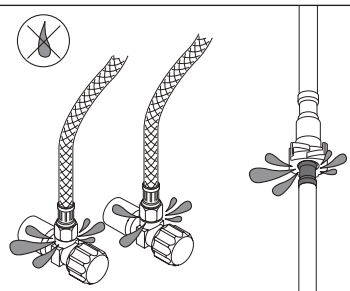

Turn on the water suppliers, Shut off the faucet and check for leaks.

DIMENSIONS

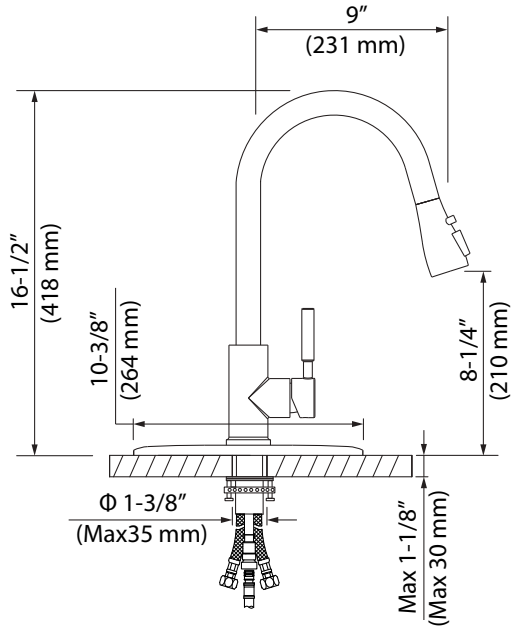

CLEANING AND CARE

Our Kitchen and bathroom products are made of solid brass to comply with the needs of the market with regard to design and functionality. To avoid damage to the product, it is necessary to take proper care of it.

Clean the faucet often with a soft cloth to keep it looking like new. For heavy cleaning you can use mild liquid detergents or non-abrasive liquid polisher. Rinse with water and dry with a soft cloth. Avoid abrasive cleaners, steel wool and harsh chemicals as these will dull the finish and void your warranty.