

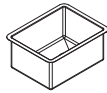

Installation Guide

Handmade Stainless Steel Undermount Kitchen Sink



K1-S14

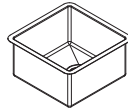

K1-S16

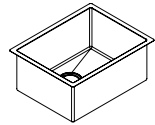

K1-S23

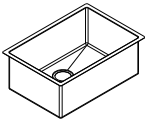

K1-S26

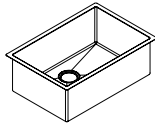

K1-S28

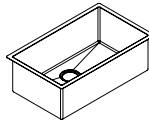

K1-S30

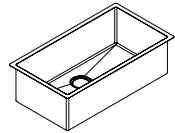

K1-S33

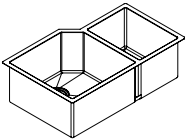

K1-D32

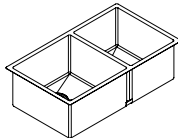

K1-D33-BS

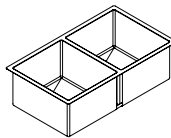

K1-D33-EQ

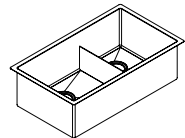

K1-D33-LD

Installation

General Recommendations:

- 1- Read the instruction carefully before installation. Inspect the sink prior to installation to make sure that is not been damaged during shipping.
- 2- The instructions are for installation with solid surface and composite material countertops. KIBI recommends professional stone fabricator to perform the installation and is not responsible for damage to countertop or sink during installation.
- 3- Template are only provided as a guide. Place template on sink to ensure the template will give you the proper cutout for the sink.
- 4- Observe all local plumbing and building codes.
- 5- Keep this booklet and the receipt (or other proof of date and place of purchase) for this product in a safe place. The receipt is necessary to request warranty parts.
- 6- KIBI does not accept any liability for damage to countertop, sink fixture, faucets or personal injury during installation. Warranty is void if installation guide is not followed.

Please keep the box and packaging materials until your product is completely installed.

NOTE: These sinks are intended for indoor kitchen use only. They are not rated for outdoor use. Installation of this sink in an outdoor setting will void any warranty on this product.

Tools you may need

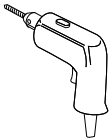

Drill

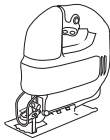

Jig Saw

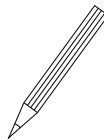

Pencil

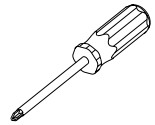

Phillips Screwdriver

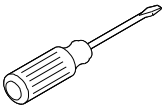

Screwdriver

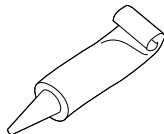

Silicone sealant

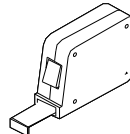

Tape Measure

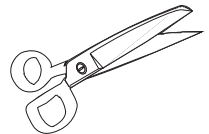

Scissors

Determine Reveal Type

KIBI Undermount sinks can be installed in three different types:
Use scissors to cut along the line of paper template for your desired reveal type
(Negative, Positive or Flushed reveal)

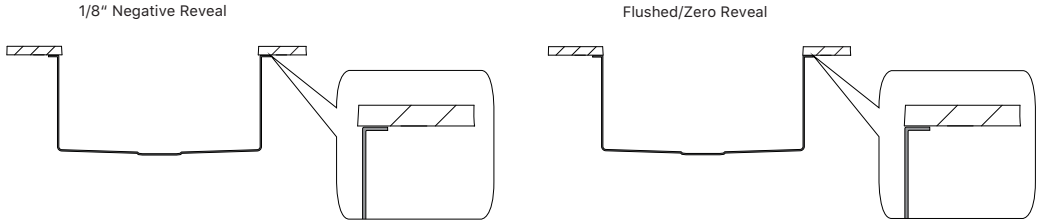

KIBI Recommended Installation type

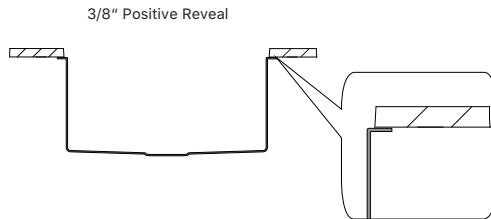

Flush installation: Countertop edge and sink edge are in alignment for a continuous look.

Negative installation: Sink sides are recessed 1/8" behind the countertop rim.

Positive installation: Countertop rim is cut back 3/8" from sink sides to reveal the sink edge.

Caution: When determining sink placement, be sure to check that there is adequate clearance behind the sink for any faucet(s) and your backsplash, as well as clearance for a full range of motion for faucet spouts and handles.

Installation

1

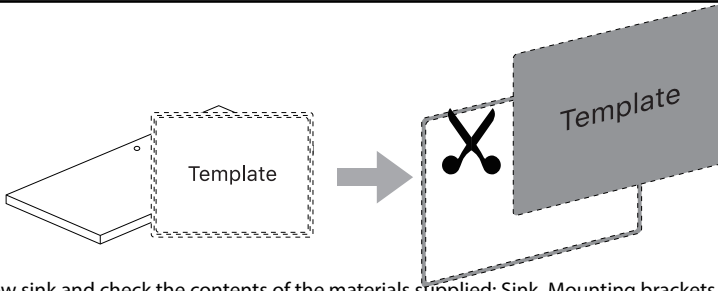

Unpack the new sink and check the contents of the materials supplied: Sink, Mounting brackets, and Cutout template (depending on model). Contact your retailer if any product is damaged or missing prior to installation. Never install a damaged sink as it can void your warranty. Determine the installation type you prefer, cut out the appropriate template for your sink model.

⚠ Make sure clearance is suitable for backsplash, faucet, and plumbing for the sink.

2

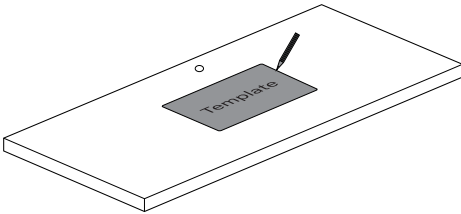

Trace template on countertop with a pencil.

3

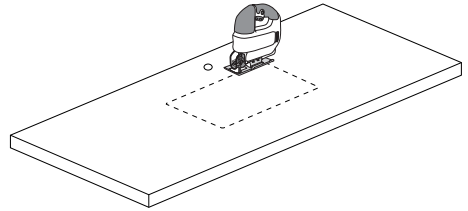

Cut the opening in the countertop by carefully following the traced line.

NOTE: Do not cut the sink opening with traditional saw cut method.

4

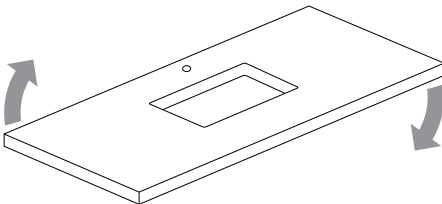

Turn countertop over and align sink with countertop.

5

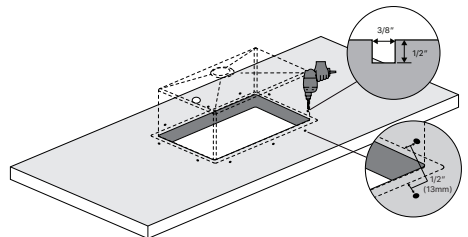

Decide location for mounting brackets, drill 3/8"X1/2" deep hole in the countertop.

6

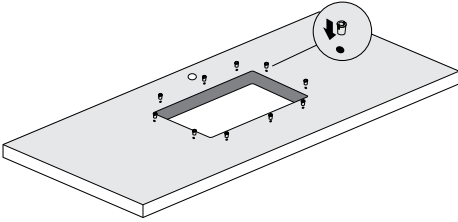

Install anchors into drilled holes and lightly tap with a hammer until flush.

7

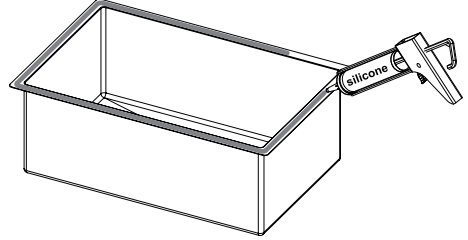

Apply a bead of silicone adhesive (not included) to the sink edges.

⚠ **Do not use epoxy.**

8

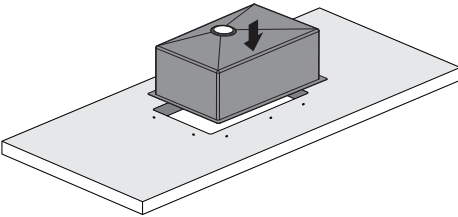

Position the sink in the opening.

9

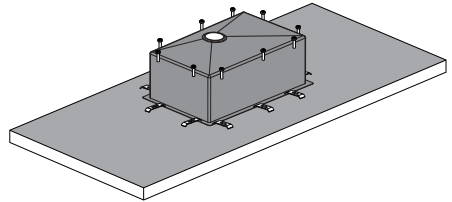

Tighten the fasteners until just snug. Check the alignment of the sink in the opening.

10

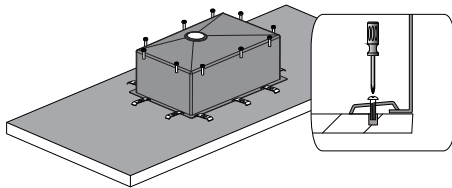

Tighten the mounting hardware evenly.

11

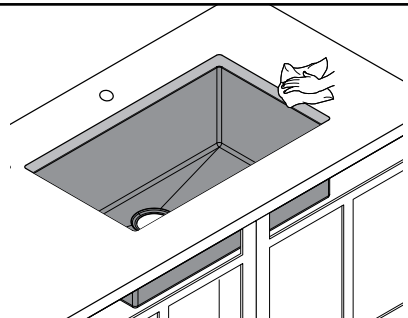

Wipe off any excess caulk.

⚠ Allow the caulk to cure according to the manufacturer's instructions before using the sink.

Dimensions

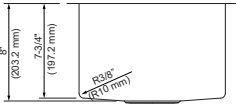
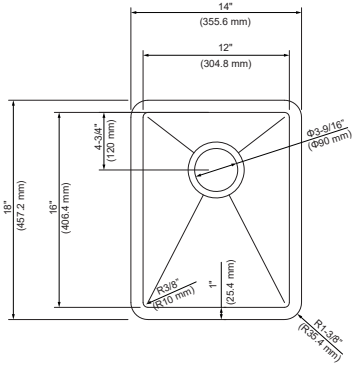

K1-S14
14"X18"X8"
 Min Cabinet Size: 18"

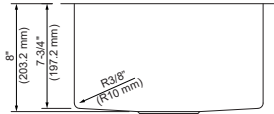
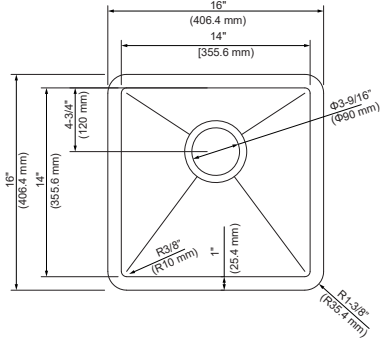

K1-S16
16"X16"X8"
 Min Cabinet Size: 18"

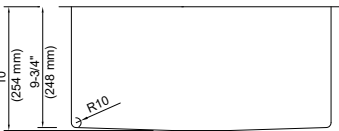
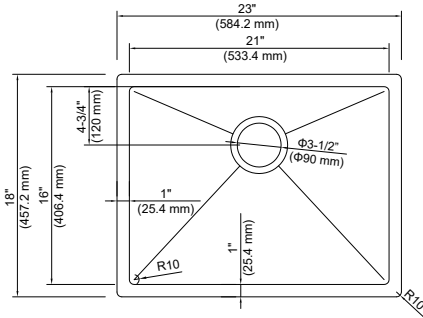

K1-S23
23"X18"X10"
 Min Cabinet Size: 27"

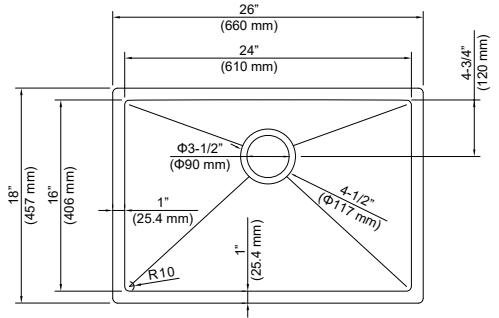

K1-S26
26"X18"X10"
 Min Cabinet Size: 30"

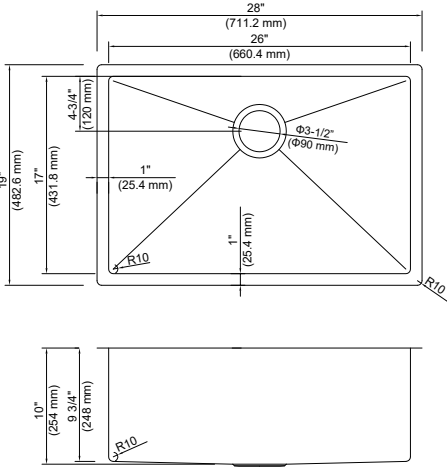

K1-S28
28"X19"X10"
Min Cabinet Size: 30"

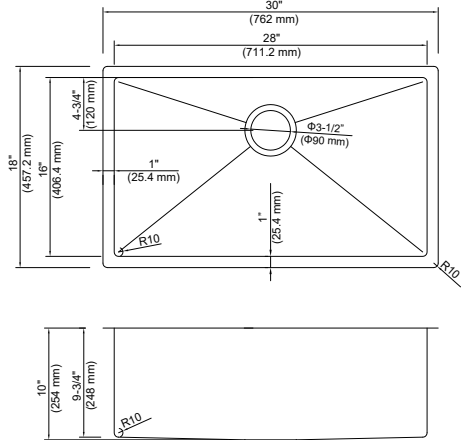

K1-S30
30"X18"X10"
Min Cabinet Size: 33"

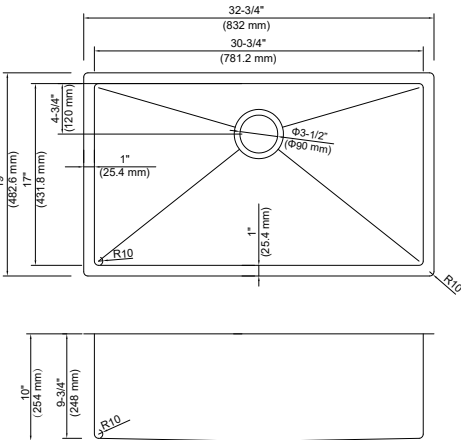

K1-S33
32-3/4"X19"X10"
Min Cabinet Size: 36"

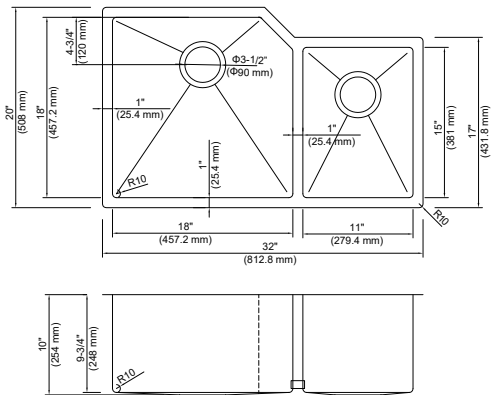

K1-D32
32"X20"X10"
Min Cabinet Size: 36"

Dimensions

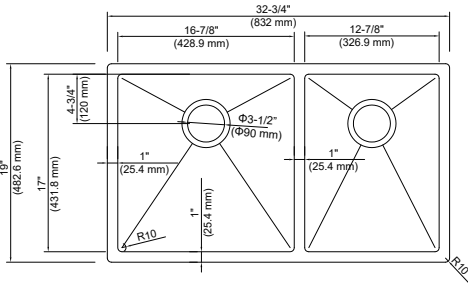

K1-D33-BS
32-3/4"X19"X10"
Min Cabinet Size: 36"

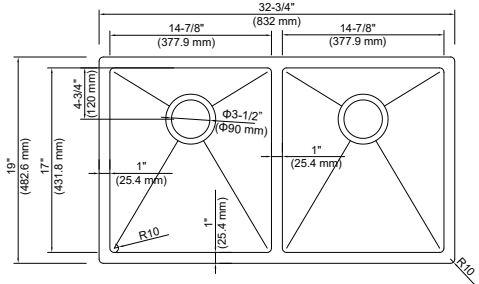

K1-D33-EQ
32-3/4"X19"X10"
Min Cabinet Size: 36"

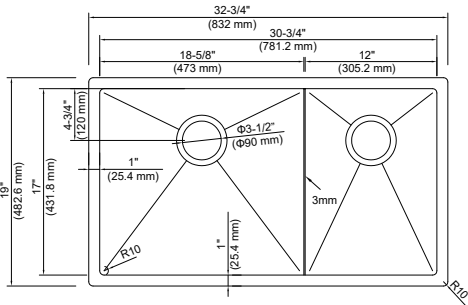

K1-D33-LD
32-3/4"X19"X10"
Min Cabinet Size: 36"

If you've followed the instructions carefully and your sink still does not work properly, take these corrective steps.

Trouble - Shooting	
PROBLEM	ACTION
Scratches	Use a nylon pad with an iron-free abrasive polishing compound. Follow the direction of the original brush lines and the scratch will disappear as it's blended into the original finish. Be careful to not polish too aggressively since you'll polish out the original brush lines and end up with a shiny spot.
Water deposits	Regular routine cleaning can usually prevent lime scale deposits from hard water. Do not allow excessive build up before treating. Soaking in a 25% vinegar solution or a 5% nitric acid solution can remove these hard water spots. Periodically rub with a nylon-bristled brush or a fine-mesh synthetic scouring pad. Rinse and towel dry after treatment.
Rust marks	If rust marks develop due to presence of, or contact with, ferrous (iron-containing) materials, swab with a sponge wetted with a diluted (10-15%) solution of nitric acid (HNO ₃) and follow with routine cleaning. Avoid prolonged contact of ferrous materials (like cast iron pans) with stainless steel. Nitric acid in dilute concentrations (<20%) is the only acid that is safe to use on stainless steel.

Care & Maintenance

Clean regularly with normal detergent and warm water.

Always make a habit of drying your sink after use and buffing with a soft cloth. This will ensure that no build up of limescale or other mineral deposits can occur.

Clean the sink once a week using a non-abrasive cleanser such as Comet and a clean soft sponge. Scrub in the same direction as the natural grain of the sink.

Never let soap or other household cleaners to dry on the surface of the sink. Most products contain additives which will affect the finish of the sink.

Never use bleach solutions on the sink, as it is harmful to stainless steel. If left on the sink too long it can cause surface pitting.

Never use a steel wool pad to clean your sink. Doing so may damage the sink's surface and cause discoloration.

Minor scratching of the sink's surface is extremely difficult to avoid and is not something to be unduly concerned about. These marks are usually only superficial and can be removed with a proprietary stainless steel cleaner.

Use of rinse grids will reduce exposure of the bottom of the sink to scratches.

Limited Lifetime Warranty

This product has been manufactured and inspected to the highest possible quality standards. Kibi sinks carry a limited lifetime warranty for residential use.

Should you experience any defects in materials or workmanship within the warranty period, we will repair or replace the defective product, subject to the following conditions:

- Any claim made under this warranty must include a copy of a valid proof of purchase showing the date and place of purchase.
- Our obligation under this warranty is to the original purchaser only, and may not be transferred.
- Product replacement does not include shipping costs or labor installation costs.
- This warranty applies to residential installations only.
- Kibi reserves the right to examine product in question and its installation prior to replacement.
- If an identical replacement product is not available, Kibi reserves the right to replace the defective product with a similar product.

NOTE: Accessories such as rinse grids, cutting boards, strainers are not covered by this warranty.

This warranty relates to defects in manufacture, materials or workmanship in a Kibi stainless steel kitchen sink supplied for installation into domestic premises in the United States. It does not extend to :

- Damage resulting from failure to maintain the product in accordance with the Care and Maintenance instructions in this manual.
- Normal wear and tear, scratches or accidental damage.
- Faults arising from improper use and/or installation.
- Defects in accessories, strainers and rinse grids.

All incidental or consequential damages are specifically excluded. No additional warranties, express or implied are given, including but not limited to, any implied warranty of merchantability or fitness for a particular purpose.

Some states do not allow the exclusion or limitation of incidental or consequential damages or limitations on how long an implied warranty lasts, so the above limitations or exclusions may not apply to you.

This warranty gives you specific legal rights, and you may also have other rights which vary from state to state.

